

#	QTY	PART NUMBER	DESCRIPTION
1	2	31-005	HANDLE - RECESSED/LOGO/ZINC
2	8	32-011	CORNER-LARGE SQUARE/ZINC
3	4	34-012	CATCH - RECESSED W/LOGO/ZINC
4	8	35-005	CLAMP - LARGE 4 HOLE/RIV/ZINC
5	4	40-003	FOOT - METAL, ZINC
6	2	41-008	RACK RAIL-08 SPACE
7	1	83-008	BADGE - GRUNDORF

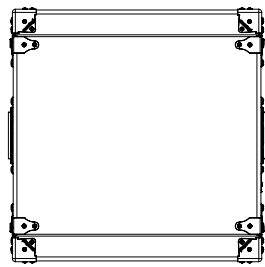

Top View

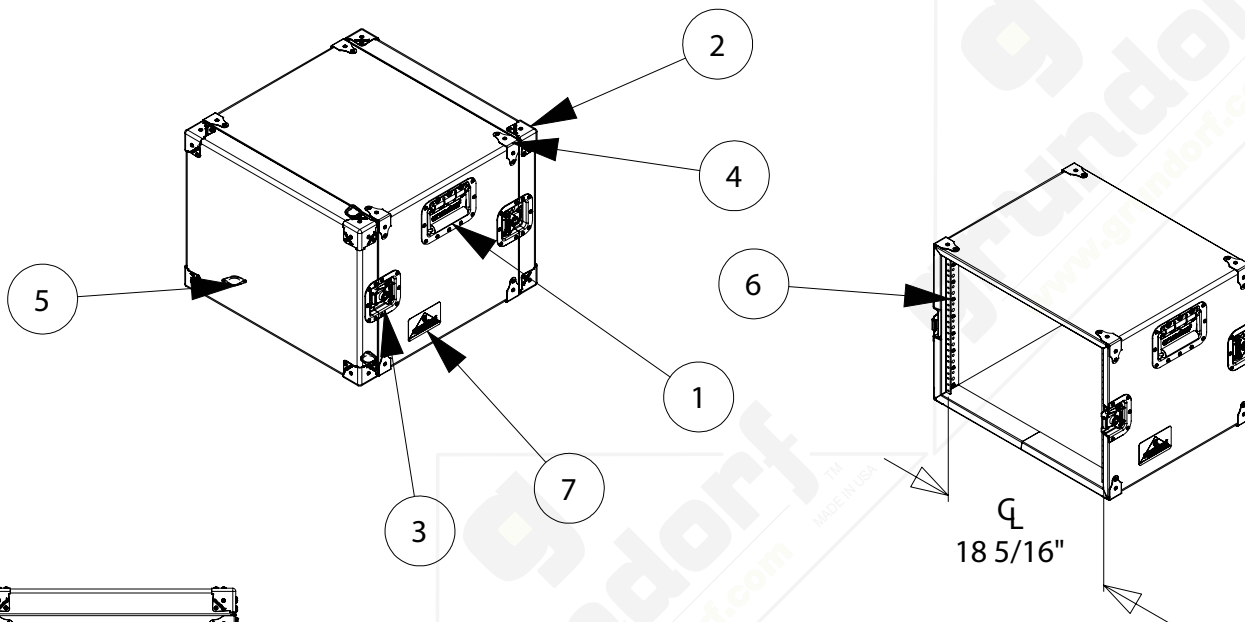
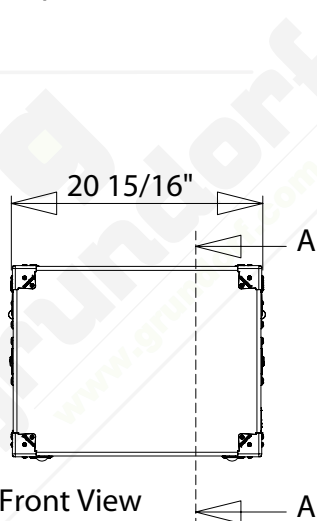

Front View

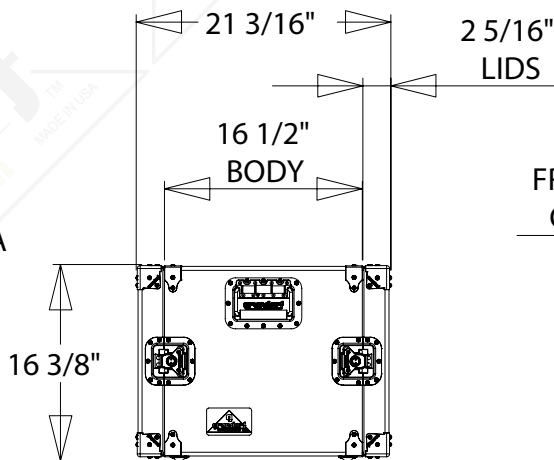

Side View

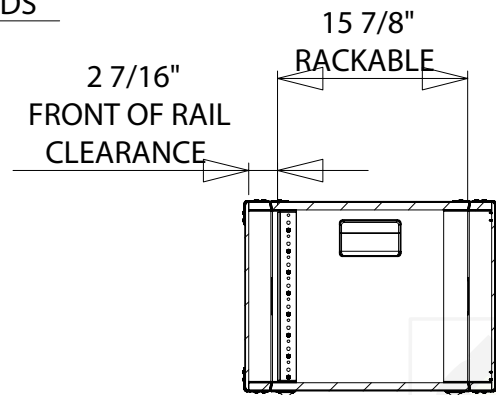

SECTION A-A